

Operation Manual

VIESSMANN

VITOWELL EASY P1
Instant Water Heater

VITOWELL EASY P1



Parts Identification

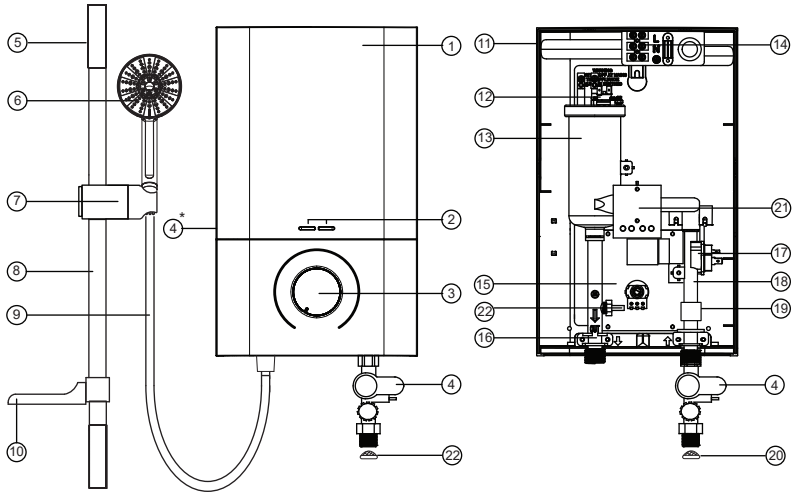

1. Front Cover
2. LED Indicators
3. Temperature Control Knob
4. Stop Valve
5. Rail Support / Wall Bracket
6. Handshower
7. Adjustable Shower Holder
8. Slider Rail
9. PVC Hose
10. Soap Tray
11. Heater Base

12. Thermostat
13. Heater Tank
14. Terminal Block
15. Main PCB Board
16. Water Outlet Connection
17. TRIAC
18. Water Inlet Connection
19. Flow Sensor
20. Mesh Filter
21. LED Board
22. Thermistor

Important Safety Information

■ Products manufactured by us are safe provided they are installed, used and maintained in good working order in accordance with our instructions and recommendations. Always refer to this manual if you have any doubt.

■ The appliance must be earthed. Improper grounding could cause electric shock.

■ If any of the following conditions occur, immediately switch off the mains and contact the sales agent for repair. Never attempt to repair the unit yourself.

-If the heater begins to make an odd noise, smell or smoke.

-Water temperature can not be controlled.

-If the instant water heater shows signs of a distinct change in performance.

-If found water leakage from inside.

■ The appliance is not intended for use by person (including children) with reduced physical, sensory or mental capabilities, or lack of experience and knowledge, unless they have been given supervision responsible for their safety. Children should be supervised at all times when using the unit to ensure that they do not play with the appliance.

User is advised to test and adjust the water temperature before showering.

■ In times of lightning/thunder, switch off the electric supply to the instant water heater in advance to protect the instant water heater against possible damage.

■ Metallic/chrome hose and conductive control valve shall not be used. (Malaysia only)

Note: When removing the instant water heater from package, small amount of water may be found inside. This is normal as the unit is tested during manufacturing process.



■ Installation must be carried out by a qualified personnel and in compliance to the local authority regulations.

■ This instant water heater must be permanently connected to the direct main current supply. The use of a plug and socket is not recommended.

■ For the correct size of wire conductor corresponding to different electrical loading, please refer to the Electrical Loading Table.

■ This instant water heater operates at a minimum water flow rate of 2.0 L/min and maximum working pressure of 6 bars. For direct connection to the water tank, the heater must have a minimum distance of 1.0m below the water tank.

■ This instant water heater will not function if there is insufficient water flow (min 2.0 L/min) to trigger the flow switch.

■ The thermostat will automatically cut off the power supply if it has sensed an abnormal rise in water outlet temperature.

Heater Unit Installation

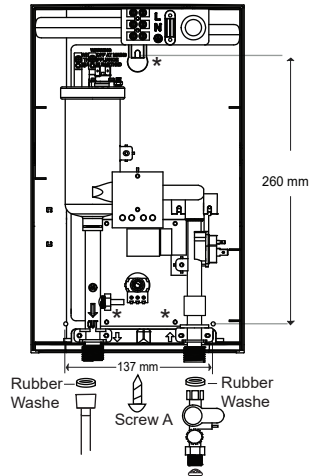
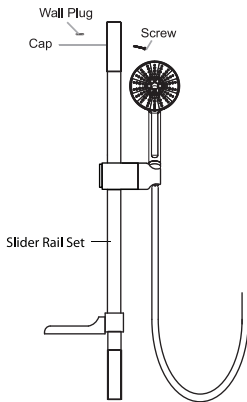

- Select a suitable position in the bathroom.
- Pull out the Temperature Control Knob and then remove the Screw A at the bottom of the unit.
- Remove the Front Cover from the bottom and then lift up the Front Cover.
- Mark 3 Screw points of the Heater Base on the wall. (Refer * marking)
- The Instant Water Heater position should be 1.5m above the bathroom floor.
- Mark 2 screw points of the Slider Rail beside the heater. It is recommended that the top of the portion is in level with the top of Instant Water Heater.
- Use 6mm diameter drill and make the wall plug holes in depth of 34mm.
- Insert the wall plugs and mount the Instant Water Heater firmly in position with the screws provided.
- Insert the Shower Holder and Soap Tray into the Slider Rail.
- Mount the Slider Rail to the Rail Bracket.
- Remove the cap from the Rail Bracket and screw the Bracket to marked position. Replace the cap.

Plumbing Procedure



This Instant Water Heater is a single point system and the “Water Outlet” can only be fitted to the PVC Hose and Handshower set provided. NO CONTROL VALVE OR FITTING CAN BE FITTED TO THE WATER OUTLET.

- Connect the Stop Valve to the Water Inlet with washer. Use correct tools to tighten the connection and be careful not to over tighten and damage the plastic nut.
- Connect the incoming water piping to the Stop Valve (1/2” BSP). Make sure to put the Mesh Filter between Stop Valve and incoming water piping.
- If in any case, the Stop Valve is not used or omitted, make sure to put the Mesh Filter between the heater unit inlet pipe and incoming water pipe.
- Turn on the water mains to drain out all plumbing dirts, at the same time fill up the heater tank. THE HEATER TANK MUST BE FILLED UP WITH WATER BEFORE TURNING ON THE ELECTRICITY SUPPLY TO PREVENT ANY DRY BURNT DAMAGE TO THE HEATING ELEMENT.
- Connect the PVC Hose and Handshower to the outlet of the Instant Water Heater, be sure to put in the Washer.
- Hook the Handshower to the Sliding Rail Shower Holder and adjust to your ideal position.
- Check if any water leakage.
- Do not use white tape during piping installation.



- THE WATER INLET AND OUTLET MUST BE INSTALLED CORRECTLY , OTHERWISE IT MAY CAUSE A DAMAGE TO THE HEATING ELEMENT.
- DO NOT APPLY PLUMBING CEMENT ON CONNECTION. WHENEVER NECESSARY, USE ONLY THREAD OR SEALING TAPE.

Electrical Installation

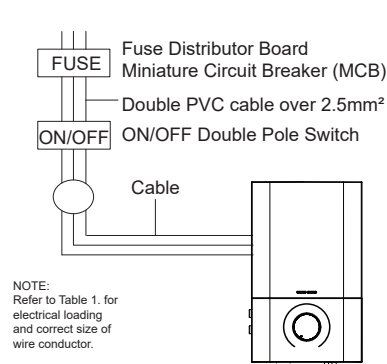

NOTE:
Refer to Table 1, for
electrical loading
and correct size of
wire conductor.

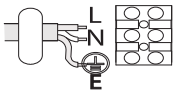

BROWN — LIVE (L)
or RED
BLUE or BLACK — NEUTRAL (N)
GREEN — EARTH (⊕)
or GREEN/YELLOW

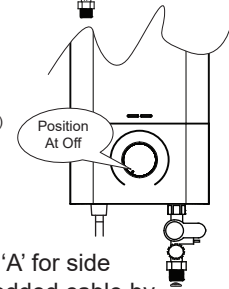

PROCEDURE:

Insert the cable through 'A' for side entry or 'B' for wall embedded cable by cutting a hole through the source cord rubber holder.

Connect the cable to Terminal Block and fully tighten them as follow

BROWN or RED — LIVE (L)
BLUE or BLACK — NEUTRAL (N)
GREEN/YELLOW — EARTH (⊕)

When replace back the Front Cover, please take note the below procedure:

- To ensure the correct position, turn the Temperature VR Knob insert to OFF position as shown in Fig A. (at the Heater Base)

- To install the Front Cover, turn the Temperature Control Knob to OFF position to align with the VR Knob connect the LED display cable from front cover to the Main Control PCB. Clamp the cable to the correct position. CHECK IF THE WIRING CONNECTION IS CORRECT and replace the cover.

- Fix back the Screw A.

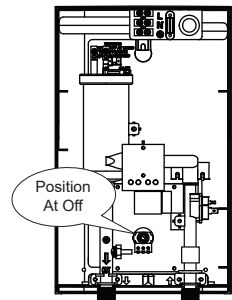
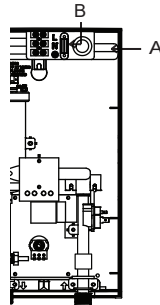

Fig A.

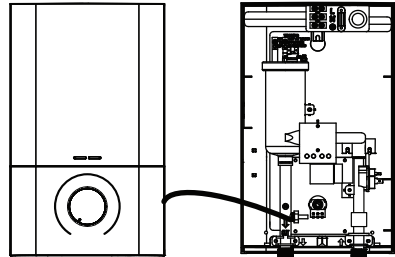

Fig B.



This appliance must be EARTHED. Improper grounding could cause electrical shock.

Remember to SWITCH OFF at mains before carrying out any electrical work.

Refer to the Electrical Loading Table for the correct cable size. Use double coated flexible cable having nominal cross-sectional area 2.5mm².

Lead the power cable from the MCB to a "ON/OFF" double pole linked switch having a contact separation of at least 3mm in all poles outside the bathroom, then lead a cable connected to Terminal block inside the unit.

Electrical Loading Table

Voltage (AC)	Power (kW)	Current (A)	Minimum Conductor Size (csa)			On/Off Switch (A)	Fuse / MCB (A)
			mm ²	Conduit Cable	Flexible Cable		
240~50/60Hz	3.6 <small>(Malaysia/Modal)</small>	15.0	4.0	7 / 0.85 mm	56 / 0.30 mm	20	20
230~50/60Hz	3.3	14.4	2.5	7 / 0.67 mm	50 / 0.25 mm	20	20
220~50/60Hz	2.4	10.9	2.5	7 / 0.67 mm	50 / 0.25 mm	20	20
	3.5	15.9	2.5	7 / 0.67 mm	56 / 0.25 mm	20	20
	4.5	20.5	2.5	7 / 0.67 mm	56 / 0.25 mm	32	32
	6.0	27.3	4.0	7 / 0.85 mm	56 / 0.30 mm	32	32

Test Run

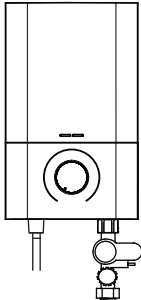

- Turn on the water supply and Stop Valve, the water will flow through the Handshower.

- Switch on the electrical supply.

Turn the Temperature Control Knob to 'ON', the Red Indicator light (Power) will turn on, hot water will flow out within a few seconds. The more Temperature Control Knob being turned in clockwise direction, the hotter the shower is.

- The shower might not be hot enough even at 'MAX' position if incoming water supply from the mains is too cold or pressure water is too high. In this case, you may adjust the Stop Valve to reduce the water inflow in order to get the desired showering temperature.

- Switch OFF the electricity supply after shower.

Handshower Spray Action

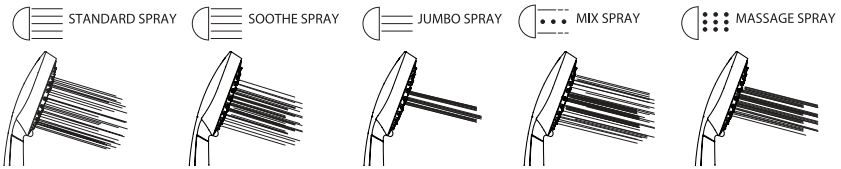

This innovative adjustable Handshower has 5 different spray actions (STANDARD, SOOTHE, JUMBO, MIX, MASSAGE). The actions are described as above.

- ! Clean the Handshower Head holes by using the soft brush from time to time. Recommended once a week. Note: Take care not to damage the holes of the Handshower Head during cleaning.

Maintainance

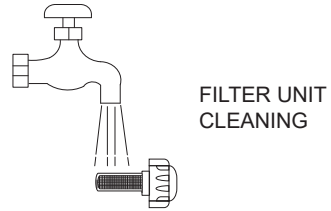
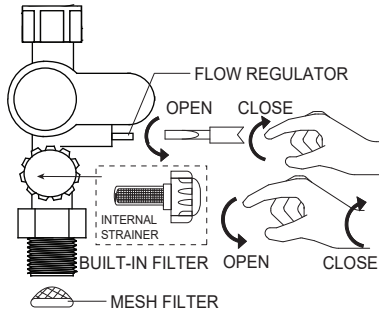

Read the section 'IMPORTANT SAFETY INFORMATION' first.

■ **CLEANING PRECAUTION!**

Do not use thinner, alcohol, petrol or any other organic solution to clean the set, use only a damp cloth with mild detergent.

■ **CLEAN THE FILTER REGULARLY.**

There are two filters located at the stop valve, one is Mesh Filter (installed at the incoming water supply), another one is the built-in filter as shown.

■ Clean the Mesh Filter regularly to prevent blockage. Remove the built-in filter by turn it anti-clockwise as shown . Take out the Filter and flush it with water to remove any trapped sendiments.

Troubleshooting

Problem/Symptom	Cause	Action/Cure
Electric Water Heater fail to operate, no power.	Interrupted power supply.	Check the wire connection and main power supply. If it still fail to operate, contact Viessmann Customer Service Call Centre.
	Electric Water Heater malfunction.	Check other appliances are having same phenomenal and contact local Electricity Supply Company. If it still fail to operate, contact Viessmann Customer Service Call Centre.
Water too hot.	Not enough water flowing through the shower.	Increase flow rate via water flow controller or 3 in 1 Stop valve.
		Blocked of shower head - clean or replace.
	Blockage in water supply.	Check if 3 in 1 stop valve are fully turns on. Cleaning Mesh Filter and Built In Filter.
	Incoming water temperature too high.	Reduce the setting temperature via temperature adjuster.
Water hot after close and reopen of 3 in 1 Stop Valve or Water Tap.	Water temperature higher than set temperature when 3 in 1 Stop Valve or Water Tap is OFF a while and reopen again.	Avoid shower with water output during that period. Let the water flow few seconds before continue bathing.
Water too cool or cold.	Too much water flow.	Reduce flow rate via water flow controller or 3 in 1 Stop Valve.
	Water pressure below minimum required and water heater not function.	Check water supply from mains or tank fed. If tank fed, replumb to mains water supply and check if the water pressure is enough. If mains fed, make sure that mains 3 in 1 stop valve is fully turns on and that there are no other restrictions in the water supply while water heater is in use.

Troubleshooting

Problem/Symptom	Cause	Action/Cure
Electric Water Heater no power.	Incoming water flow too low.	Adjust the 3 in 1 Stop valve.
	Electrical malfunction of Electric Water Heater.	Contact Viessmann Customer Service Call Centre.
	Safety Thermostat cut-out operated.	Safety Thermostat cut-out operated. Contact Viessmann Customer Service Call Centre.
Water flow too low.	3 in 1 Stop Valve Filter/Mesh Filter blocked.	Clean the filter.
	3 in 1 Stop Valve not fully open.	Open 3 in 1 Stop Valve to desire flow rate.
	Water supply insufficient.	Check house water supply.

NOTES

It is advised all electrical maintenance/repairs to the shower should be carried out by a suitably qualified person. In the unlikely event of Electric Water

Heater failure other than detailed in the fault finding page, please contact Viessmann Customer Service Call Centre for advice.

Wiring Diagram

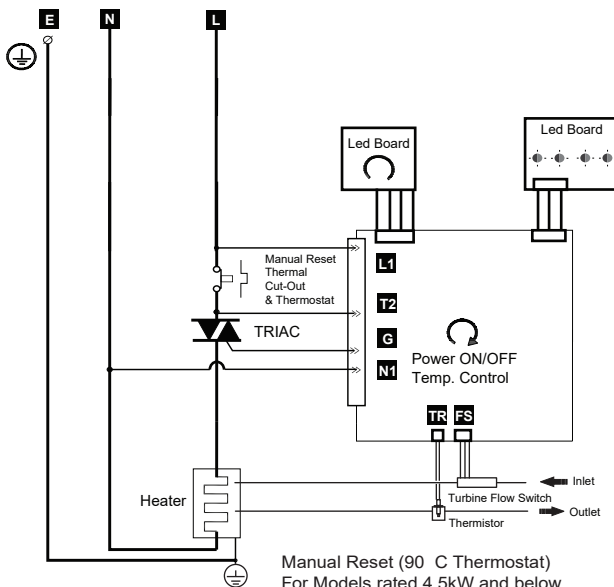

Electrical Specification

TYPE	ELECTRONIC POWER CONTROL
ELECTRICAL LOADING	3.3kW 230Va.c. 50/60Hz
Min. WATER FLOW RATE	2 Liter / min.
Min. INLET WATER PRESSURE	0.1 Bar (10kPa)
Max. INLET WATER PRESSURE	6 Bar (0.6MPa)
WATER CONNECTION	1/2" BSP SINGLE POINT SYSTEM
DIMENSIONS	210 x 343 x 87 mm
WEIGHT	1.6 Kg (No Pump)

Note : The specification, actual product's cosmetic design and accessories parts shown are correct at the time of printing and may be subjected to change without prior notice.

VISSMANN
VITOWELL



CUSTOMER CARE
+65 6970 8411

VISSMANN GROUP
VISSMANNSTRASSE 1, 35108 ALLENDORF (EDER),
GERMANY

REGIONAL OFFICE
VISSMANN SINGAPORE PTE.LTD
25 INTERNATIONAL BUSINESS PARK #04-01/02
GERMAN CENTRE
SINGAPORE (609916)